



Custom Curtain Walls

Custom Made Industrial Space Partitioning Systems



Industries Served:

- Manufacturing & Assembly Plants
- Warehouses
- Storage Facilities
- Aircraft Separation
- Schools
- Offices
- Woodworking Facilities
- Auto Body Shops
- Retail
- Restaurants
- Home Enthusiasts
- And More!!

Ideal For:

- Confining Contaminants
- Separating Space
- Controlling Temperature, Light, & Odors
- Reducing Energy Costs
- And More!



Improving Profitability Through Flexible Space Separation

Let us do the work for you!

Features & Benefits

Benefits of Goff's Curtain Walls

Include:

- Separates conflicting tasks/work environments
- Quickly creates privacy areas
- Improves working conditions
- Easily slides out of the way when not needed
- Helps to control contaminants, temperature, odors, sound and light
- Fast Delivery!

Features Include:

- 14 oz. vinyl coated polyester fabric with 20 mil. clear PVC window section
- Curtains meet NFPA 701 & California State Fire Marshal Standards
- Double Lock Stitching with mildew/rot resistant thread
- Finished Edges with 2" Industrial Strength Velcro for attaching to adjacent curtains
- Fully enclosed, sewn in, galvanized chain in the bottom hem for motion reduction
- Resistant to most chemicals
- Easy to install, clean and replace
- Eliminates costly brick and mortar permanent type walls



Materials, Construction & Sizes

Goff's Curtain Walls are Custom Made for each Application.

Curtains can be made in any length up to 100' high and in any layout.

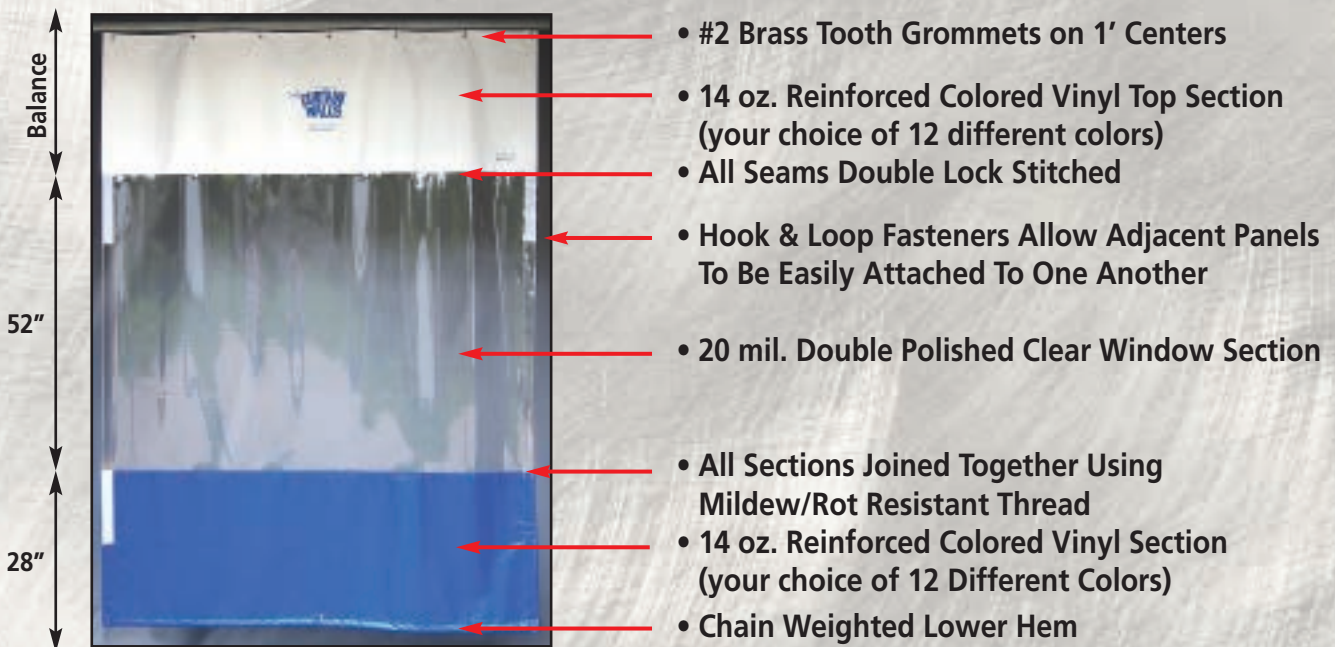

14oz Vinyl Color Options

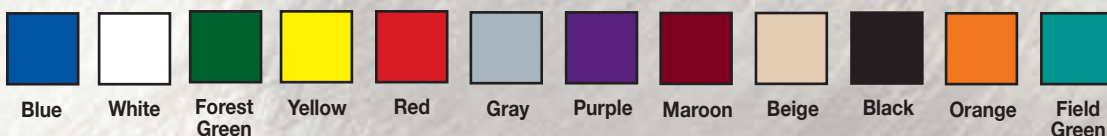

Ordering your custom product is easier than ever!

Mounting Hardware

Goff's Curtains come complete with mounting hardware!

For smooth, easy movement all curtain systems come complete with a heavy duty 16 gauge galvanized steel track and roller hook system.

Goff's unique Universal Track Splice allows for suspend, face, or flush mounting. Goff's will send you the proper assortment of hardware for your dimensions and layout.

Floor Mount Hardware Also Available! All hardware carries a limited lifetime warranty. For a complete list of hardware please visit www.goffscurtainwalls.com/curtain-walls/curtain-wall-hardware

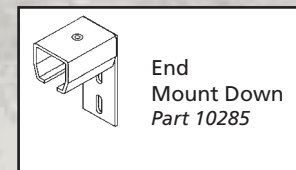
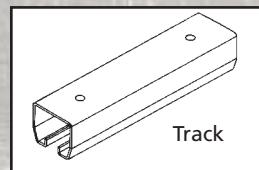
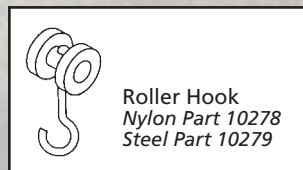
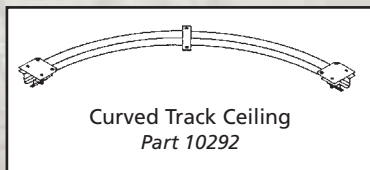
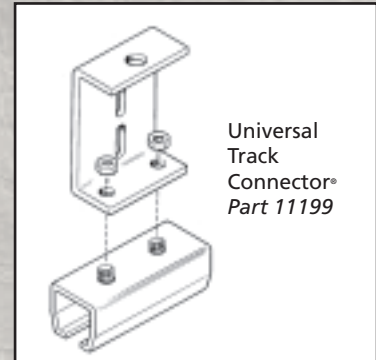

Options & Accessories

Goff's Curtain Walls can be equipped with a number of accessories and add-on's

Floor Mount Wind Ties – Easy to fasten tie downs are sewn directly onto the bottom of the Curtain. Available in 2 models.

Filter Panels – Easily removable and replaceable in 2 sizes: 2' x 4' or 4' x 4'. Filter sections are reinforced via a nylon scrim pattern.

Strip Door – 3' wide x 7' high replaceable strip door sewn directly into the curtain

Valance Panels – Stationary custom vinyl pieces manufactured to any size to seal area above the curtain. Perfect for slanted ceilings.

Floor Sweep Attachment – 6" replaceable vinyl piece to seal the gap between the Curtain Wall's bottom and the floor. Perfect for pitched floors.

Curtain Wall Cleaner & Shield – Shield All provides a semi-transparent, protective coating. Cleaner is a safe and effective way to clean the entire Curtain Wall without damaging the vinyl.

Steel Rollers – Recommended for curtains over 15' high

Vinyl Mesh – 11 oz 17x11 Mesh Scrim Available for improved airflow.

Custom Logos – Personalize your curtain with your company logo or slogan. Custom priced based on size, colors and quantity.



• Custom Curtain Walls • Custom Curtain Walls • Custom Curtain Walls • Custom Curtain Walls •

